

GERSAN

ELEKTRİK TİC. ve SAN. A.Ş.

DÖŞEME ALTI KABLO KANALLARI

Underfloor Cable Trunkings

تمديدات ارضيات مرتفعة



ASTA



KEMA



ISO 9001-14001-18001

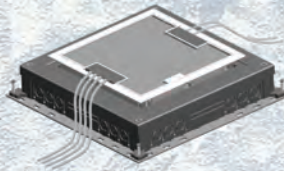

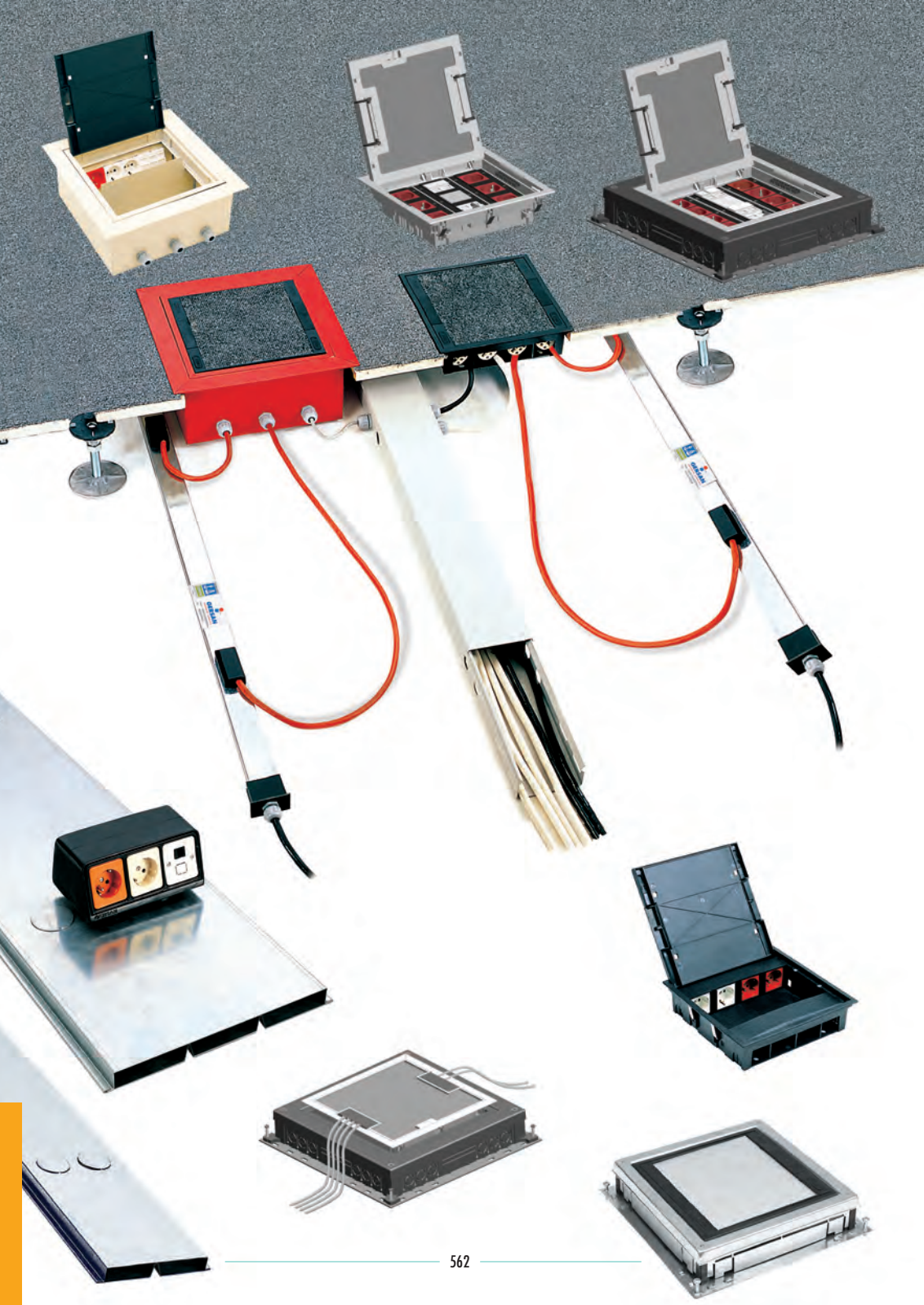

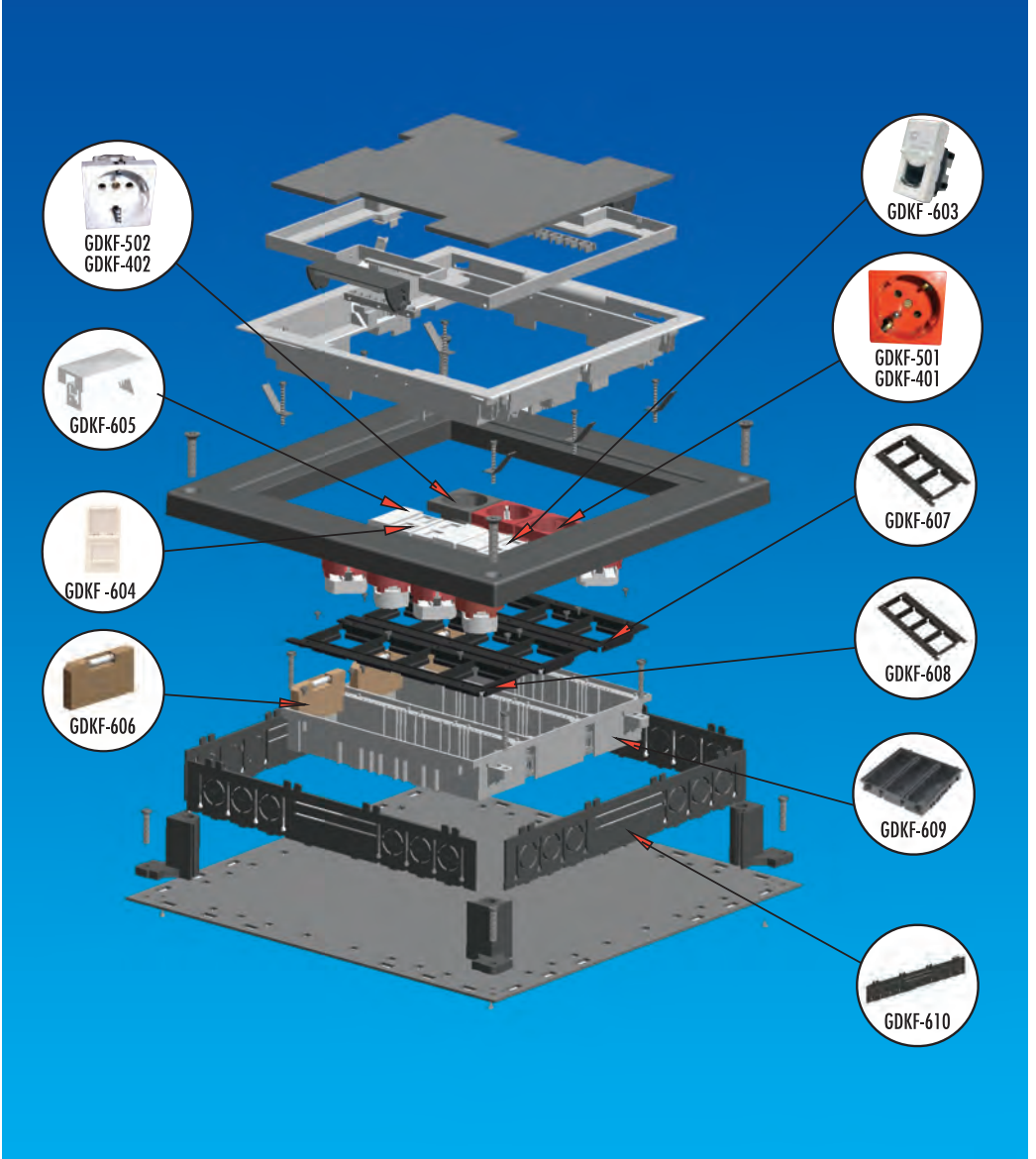

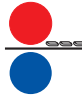
DÖŞEME ALTI BUATI *Junction box*

صندوق تقاطع



DÖŞEME ALTI BUATI (SİSTEM BUATI)

Junction box

صندوق تقاطع

Sipariş kodu Order code	Stok kodu Stock code	Ağırlık (Kg/ad.) Weight (Kg/unit)
رمز الطلب	رمز المخزن	الوزن (كجم/وحدة)
GDK-31	101500310PLS1	5,310

GDK-31

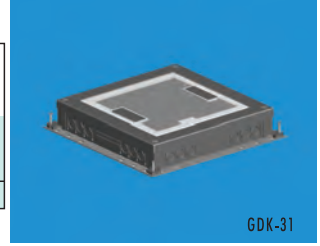

GDK-31



BUATI İÇİ PRİZ KASASI

Socket case

علبة قابس

Sipariş kodu Order code	Stok kodu Stock code	Ağırlık (Kg/ad.) Weight (Kg/unit)
رمز الطلب	رمز المخزن	الوزن (كجم/وحدة)
GDK-32	101500320PLS1	1,845

GDK-32

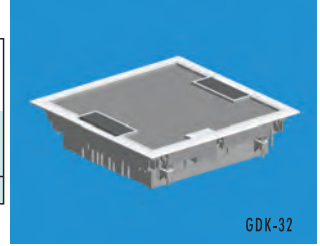

GDK-32

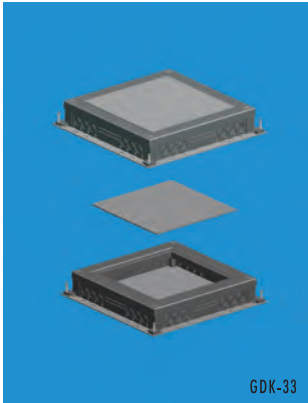

BOŞ BUAT KUTUSU

Junction box without socket

علبة تقاطع بدون المقابس

Sipariş kodu Order code	Stok kodu Stock code	Ağırlık (Kg/ad.) Weight (Kg/unit)
رمز الطلب	رمز المخزن	الوزن (كجم/وحدة)
GDK-33	101500330PLS0	4,660

GDK-33

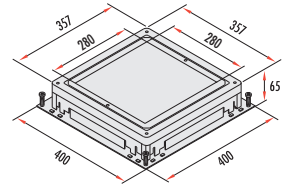

İSTEĞE BAĞLI OLARAK BUATLAR IP43 STANDARTLARINA GÖRE ÜRETİLİR.
In accordance to requirement junction boxes are be manufactured with IP43 protection degree
بدرج حماية تعتمد على المتطلبات IP 43

DÖŞEME ALTI BUATI *Junction box* صندوق تقاطع

GDK-34

GRANİT TIPI BUAT

Junction box

علبة توصيل من الجرانيت

Sipariş kodu Order code	Stok kodu Stock code	Ağırlık (Kg/ad.) Weight (Kg/unit)
رمز الطلب	رمز المخزن	الوزن (كجم/وحدة)
GDK-34	101500340PLS1	5,310

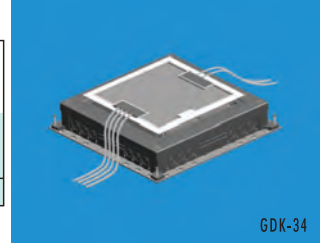

GDK-34

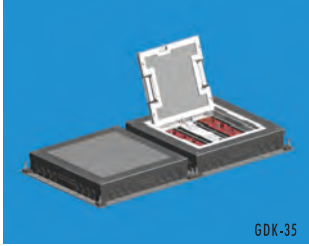

GDK-35

İKİLİ DÖŞEME ALTI BUATI

Double under floor junction box

علبة توصيل تحت أرضية زوجية

Sipariş kodu Order code	Stok kodu Stock code	Ağırlık (Kg/ad.) Weight (Kg/unit)
رمز الطلب	رمز المخزن	الوزن (كجم/وحدة)
GDK-35	101500350PLS1	9,970

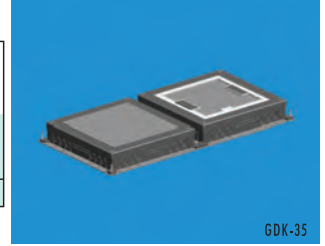

GDK-35



GDK-07

YÜKSELTİLMİŞ DÖŞEME İÇİN BUAT

Junction box for high-floor

علبة توصيل للأدوار العليا

Sipariş kodu Order code	Stok kodu Stock code	Ağırlık (Kg/ad.) Weight (Kg/unit)
رمز الطلب	رمز المخزن	الوزن (كجم/وحدة)
GDK-07	101500700BOYO	6,420



GDK-07



DÖŞEME ALTI (BUAT) PRİZLERİ *Sockets for junction boxes*

مقابس لعلب التوصيل



UPS PRİZ <i>UPS Socket</i> مقابس لعلب التوصيل		
Sipariş kodu <i>Order code</i> رمز الطلب	Stok kodu <i>Stock code</i> رمز المخزن	Ağırlık (Kg/ad.) <i>Weight (Kg/unit)</i> الوزن (كجم/وحدة)
GDKF-401	101504010PLSO	0,036



ŞİGORTA <i>Fuse</i> منصهر		
Sipariş kodu <i>Order code</i> رمز الطلب	Stok kodu <i>Stock code</i> رمز المخزن	Ağırlık (Kg/ad.) <i>Weight (Kg/unit)</i> الوزن (كجم/وحدة)
GDKF-606	101506060BKLO	0,017



TOPRAKLI PRİZ <i>Socket with earthing</i> مع مقبس التوصيل الأرضي		
Sipariş kodu <i>Order code</i> رمز الطلب	Stok kodu <i>Stock code</i> رمز المخزن	Ağırlık (Kg/ad.) <i>Weight (Kg/unit)</i> الوزن (كجم/وحدة)
GDKF-402	101504020PLSO	0,032



ÜÇLÜ PRİZ BAĞLAMA PLAKASI <i>Connection Plate For Three Socket</i> لوحة للاتصال للمقابس الثلاثي		
Sipariş kodu <i>Order code</i> رمز الطلب	Stok kodu <i>Stock code</i> رمز المخزن	Ağırlık (Kg/ad.) <i>Weight (Kg/unit)</i> الوزن (كجم/وحدة)
GDKF-607	101506070BLSO	0,063



DATA PRİZİ <i>Data Socket</i> بيانات المقبس		
Sipariş kodu <i>Order code</i> رمز الطلب	Stok kodu <i>Stock code</i> رمز المخزن	Ağırlık (Kg/ad.) <i>Weight (Kg/unit)</i> الوزن (كجم/وحدة)
GDKF-603	101506030BKLO	0,012



DÖRTLÜ PRİZ BAĞLAMA PLAKASI <i>Connection Plate For Four Socket</i> لوحة للاتصال للمقابس الرباعي		
Sipariş kodu <i>Order code</i> رمز الطلب	Stok kodu <i>Stock code</i> رمز المخزن	Ağırlık (Kg/ad.) <i>Weight (Kg/unit)</i> الوزن (كجم/وحدة)
GDKF-608	101506080PLSO	0,078



TELEFON PRİZİ <i>Telephone Socket</i> مقبس الهاتف		
Sipariş kodu <i>Order code</i> رمز الطلب	Stok kodu <i>Stock code</i> رمز المخزن	Ağırlık (Kg/ad.) <i>Weight (Kg/unit)</i> الوزن (كجم/وحدة)
GDKF-604	101506040BKLO	0,008



PRİZ KUTUSU TABANI <i>Access Box Basement</i> لوصلون الى العلبة المنطقية		
Sipariş kodu <i>Order code</i> رمز الطلب	Stok kodu <i>Stock code</i> رمز المخزن	Ağırlık (Kg/ad.) <i>Weight (Kg/unit)</i> الوزن (كجم/وحدة)
GDKF-609	101506090PLSO	0,315



KÖR KAPAK <i>Blank Cover</i> غطاء دون فتحات		
Sipariş kodu <i>Order code</i> رمز الطلب	Stok kodu <i>Stock code</i> رمز المخزن	Ağırlık (Kg/ad.) <i>Weight (Kg/unit)</i> الوزن (كجم/وحدة)
GDKF-605	101506050BKLO	0,025



PRİZ KUTUSU KENAR PLAKASI <i>Access Box Side Plate</i>		
Sipariş kodu <i>Order code</i> رمز الطلب	Stok kodu <i>Stock code</i> رمز المخزن	Ağırlık (Kg/ad.) <i>Weight (Kg/unit)</i> الوزن (كجم/وحدة)
GDKF-610	101506100PLSO	0,170

DÖŞEME ALTI BUATI *Junction box*

صندوق تقاطع

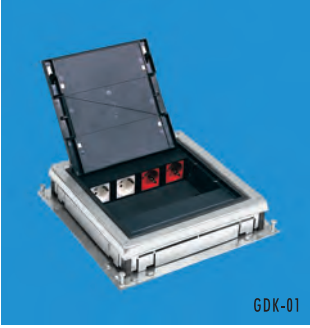

GDK-01

DÖŞEME ALTI BUATI (SİSTEM BUATI)

Junction box

صندوق تقاطع

Sipariş kodu Order code رمز الطلب	Stok kodu Stock code رمز المخزن	Ağırlık (Kg/ad.) Weight (Kg/unit) الوزن (كجم/وحدة)
GDK-01	101506070BLS0	4,110

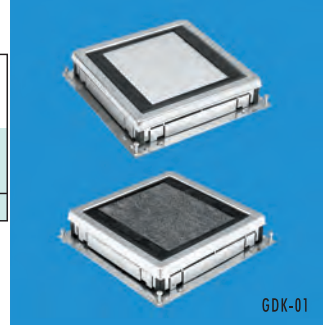

GDK-01



GDK-02

BUAT İÇİ PRİZ KASASI

Socket case

علبة قابس

Sipariş kodu Order code رمز الطلب	Stok kodu Stock code رمز المخزن	Ağırlık (Kg/ad.) Weight (Kg/unit) الوزن (كجم/وحدة)
GDK-02	101500020PLS0	1,100



GDK-02

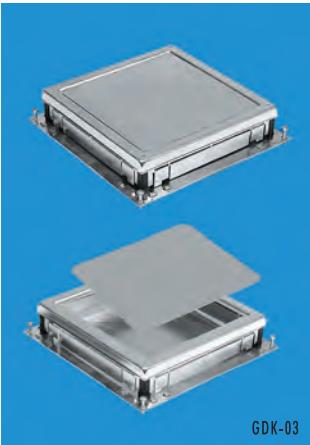

GDK-03

BOŞ BUAT KUTUSU

Junction box without socket

علبة تقاطع بدون المقبس

Sipariş kodu Order code رمز الطلب	Stok kodu Stock code رمز المخزن	Ağırlık (Kg/ad.) Weight (Kg/unit) الوزن (كجم/وحدة)
GDK-03	1015000309141	4,030

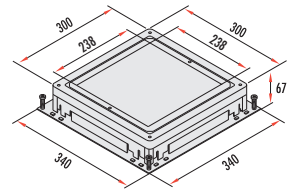

DÖŞEME ALTI BUATI *Junction box*

صندوق تقاطع

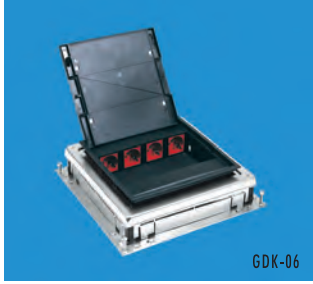

GDK-06

MERMER DÖŞEME İÇİN ÖZEL SİSTEM BUATI

Special junction box for marble floor

تقاطع خاص للأرضية الرخام

Sipariş kodu Order code	Stok kodu Stock code	Ağırlık (Kg/ad.) Weight (Kg/unit)
GDK-06	1015000609141	4,110

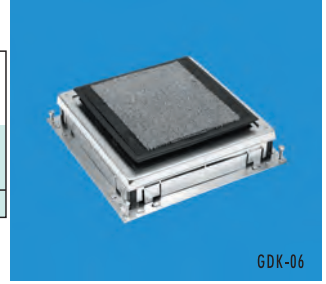

GDK-06



GDK-011

İKİLİ DÖŞEME ALTI BUATI

Double under floor junction box

علية تصويل تحت أرضية زدوجة

Sipariş kodu Order code	Stok kodu Stock code	Ağırlık (Kg/ad.) Weight (Kg/unit)
GDK-011	1015001109141	8,140

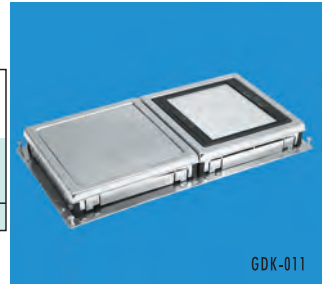

GDK-011

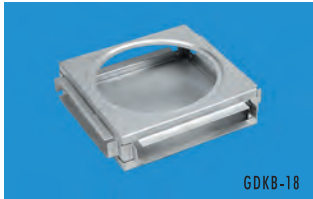

GDKB-18

DÖŞEME KANALI DÖRTLÜ BAĞLANTI ELEMANI

Crossing for underfloor type cable trays

تقاطع لأرلف الكابلات الارضية

Sipariş kodu Order code	Stok kodu Stock code	Ağırlık (Kg/ad.) Weight (Kg/unit)
GDKB-18	1015011809140	0,900
GDKB-24	1015012409140	1,100
GDKB-30	1015013009140	1,250

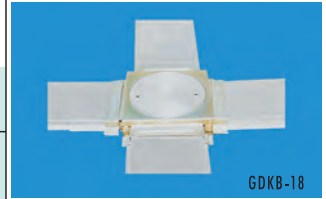

GDKB-18



GALFK-1

ALÜMİNYUM FLANŞ VE KAPAK

Aluminium flange and cover

شفة وغطاء من الالومنيوم

Sipariş kodu Order code	Stok kodu Stock code	Ağırlık (Kg/ad.) Weight (Kg/unit)
GALFK-1	10150GALFALO	0,700

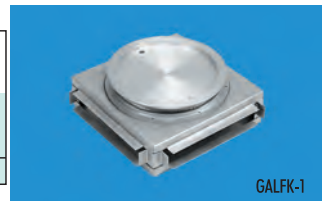

GALFK-1



DÖŞEME ALTI (BUAT) PRİZLERİ *Sockets for junction boxes*

مقابس لعلب التوصيل



GDKF-501

UPS PRİZ <i>UPS Socket</i> مقبس UPS		
Sipariş kodu <i>Order code</i> رمز الطلب	Stok kodu <i>Stock code</i> رمز المخزن	Ağırlık (Kg/ad.) <i>Weight (Kg/unit)</i> الوزن (كجم/وحدة)
GDKF-501	101505010BKLO	0,036



GDKF-501



GDKF-502

TOPRAKLI PRİZ <i>Socket with earthing</i> مع مقبس التوصيل الارضي		
Sipariş kodu <i>Order code</i> رمز الطلب	Stok kodu <i>Stock code</i> رمز المخزن	Ağırlık (Kg/ad.) <i>Weight (Kg/unit)</i> الوزن (كجم/وحدة)
GDKF-502	101505020BKLO	0,032



GDKF-502



GDKF-503

JAK PLAKAŞI <i>Jack plaketi</i> جاك اللوحة		
Sipariş kodu <i>Order code</i> رمز الطلب	Stok kodu <i>Stock code</i> رمز المخزن	Ağırlık (Kg/ad.) <i>Weight (Kg/unit)</i> الوزن (كجم/وحدة)
GDKF-503	101505030PLSO	0,006



GDKF-503



GDKF-504

TELEFON PRİZİ (RJ12) <i>Telephone Socket</i> مقبس الهاتف		
Sipariş kodu <i>Order code</i> رمز الطلب	Stok kodu <i>Stock code</i> رمز المخزن	Ağırlık (Kg/ad.) <i>Weight (Kg/unit)</i> الوزن (كجم/وحدة)
GDKF-504	101505040PLSO	0,016



GDKF-504



GDKF-505

DATA PRİZİ (RJ45) <i>Data Socket</i> بيانات المقبس		
Sipariş kodu <i>Order code</i> رمز الطلب	Stok kodu <i>Stock code</i> رمز المخزن	Ağırlık (Kg/ad.) <i>Weight (Kg/unit)</i> الوزن (كجم/وحدة)
GDKF-505	101505050PLSO	0,016



GDKF-505



BAKALİT FLANŞ <i>Bakalite fitting</i>		
حافة باكلايت		
Sipariş kodu Order code	Stok kodu Stock code	Ağırlık (Kg/ad.) Weight (Kg/unit)
رمز الطلب	رمز المخزن	الوزن (كجم/وحدة)
GDKF-401-B	1015401B0PLSO	0,020



BAKALİT KÖRTAPA <i>Bakalite pipe stopper-plug</i>		
سدادة ماسورة الباكلايت		
Sipariş kodu Order code	Stok kodu Stock code	Ağırlık (Kg/ad.) Weight (Kg/unit)
رمز الطلب	رمز المخزن	الوزن (كجم/وحدة)
GDKF-402-B	1015402B0PLSO	0,028



BAKALİT PRİZ TESPİT FLANŞI <i>Bakalite socket fixing fitting</i>		
تركيب مقبس الباكلايت		
Sipariş kodu Order code	Stok kodu Stock code	Ağırlık (Kg/ad.) Weight (Kg/unit)
رمز الطلب	رمز المخزن	الوزن (كجم/وحدة)
GDKF-403-B	1015403B0PLSO	0,048





DÖŞEME ALTI KABLO KANALLARI (DELİKSİZ) Underfloor type cable trays without holes

رفف كابلات أرضية مع فتحات

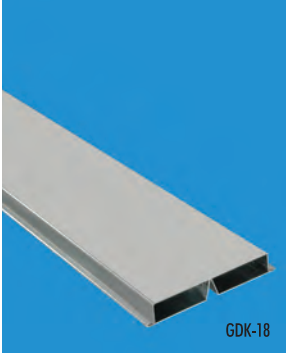

GDK-18

DÖŞEME ALTI KABLO KANALLARI (DELİKSİZ)

Underfloor type cable trays without holes

رفف كابلات أرضية بدون فتحات

Sipariş kodu Order code رمز الطلب	Stok kodu Stock code رمز المخزن	e mm	Ağırlık (Kg./mt.) Weight (Kg./mt) الوزن (كجم/م)
GDK-18	1015018018220	1-1	3,550

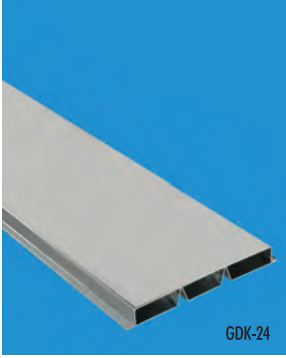
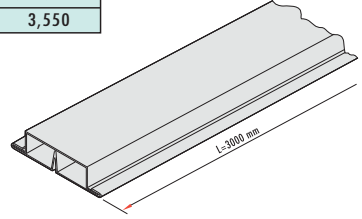
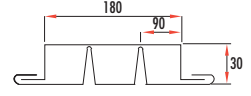

GDK-24

DÖŞEME ALTI KABLO KANALLARI (DELİKSİZ)

Underfloor type cable trays without holes

رفف كابلات أرضية بدون فتحات

Sipariş kodu Order code رمز الطلب	Stok kodu Stock code رمز المخزن	e mm	Ağırlık (Kg./mt.) Weight (Kg./mt) الوزن (كجم/م)
GDK-24	1015024018220	1-1	5,550

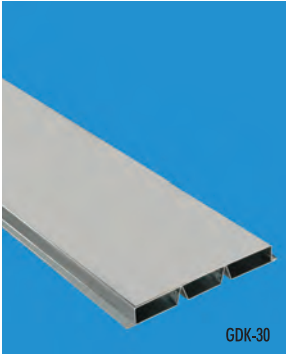
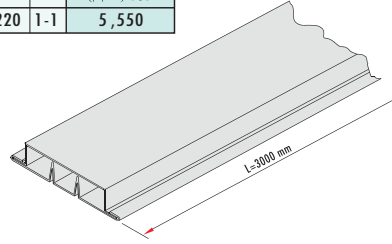
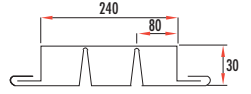

GDK-30

DÖŞEME ALTI KABLO KANALLARI (DELİKSİZ)

Underfloor type cable trays without holes

رفف كابلات أرضية بدون فتحات

Sipariş kodu Order code رمز الطلب	Stok kodu Stock code رمز المخزن	e mm	Ağırlık (Kg./mt.) Weight (Kg./mt) الوزن (كجم/م)
GDK-30	1015030018220	1-1,2	8,820

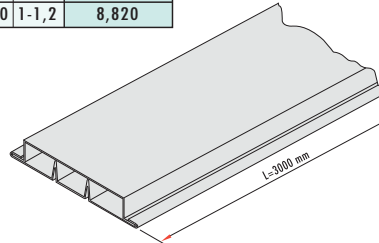
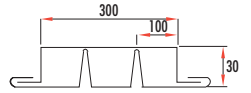

DÖŞEME ALTI KABLO KANALLARI PATLATMALI *Under floor type cable trays with explode holes*

رفف كابلات أرضية مع فتحات



GDK-18-B

DÖŞEME ALTI KABLO KANALLARI PATLATMALI

Under floor type cable trays with explode holes

رفف كابلات أرضية مع فتحات

Sipariş kodu Order code	Stok kodu Stock code	e mm	Ağırlık (Kg./mt.) Weight (Kg/mt) (الوزن (كجم/م)
GDK-18-B	1015B18018220	1-1	3,550

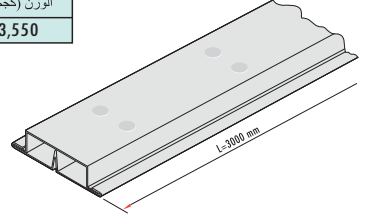
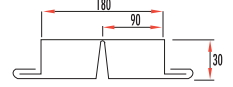

GDK-24-B

DÖŞEME ALTI KABLO KANALLARI PATLATMALI

Under floor type cable trays with explode holes

رفف كابلات أرضية مع فتحات

Sipariş kodu Order code	Stok kodu Stock code	e mm	Ağırlık (Kg./mt.) Weight (Kg/mt) (الوزن (كجم/م)
GDK-24-B	1015030018220	1-1	5,550

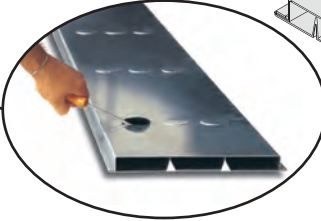
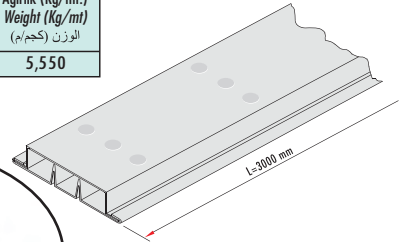

GDK-30-B

DÖŞEME ALTI KABLO KANALLARI PATLATMALI

Under floor type cable trays with explode holes

رفف كابلات أرضية مع فتحات

Sipariş kodu Order code	Stok kodu Stock code	e mm	Ağırlık (Kg./mt.) Weight (Kg/mt) (الوزن (كجم/م)
GDK-30-B	1015B30018220	1-1,2	8,820

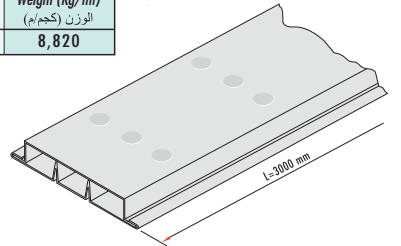
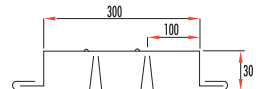



GDKE -18

KANAL EKLEME ELEMANI

Joining strap

شريط ربط

Sipariş kodu Order code رمز الطلب	Stok kodu Stock code رمز المخزن	e mm	Ağırlık (Kg/ad.) Weight (Kg/unit) الوزن (كجم/وحدة)
GDKE-18	1015E18008220	1,5	0,270
GDKE-24	1015E24008220	1,5	0,330
GDKE-30	1015E30008220	1,5	0,400



GDKE -18

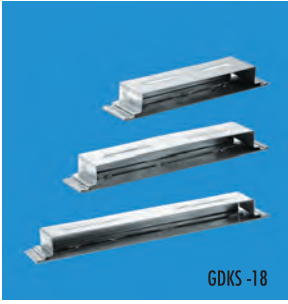

GDKS -18

KANAL SONLANDIRMA ELEMANI

End cap

غطاء طرفي

Sipariş kodu Order code رمز الطلب	Stok kodu Stock code رمز المخزن	e mm	Ağırlık (Kg/ad.) Weight (Kg/unit) الوزن (كجم/وحدة)
GDKS-18	1015S18008220	1,5	0,360
GDKS-24	1015S24008220	1,5	0,450
GDKS-30	1015S30008220	1,5	0,540



GDKS -18

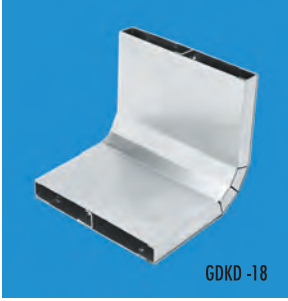

GDKD -18

90° YUKARI DÖNÜŞ ELEMANI

90° Riser

افعات 90 درجة

Sipariş kodu Order code رمز الطلب	Stok kodu Stock code رمز المخزن	e mm	Ağırlık (Kg/ad.) Weight (Kg/unit) الوزن (كجم/وحدة)
GDKD-18	1015G18008220	1,5	1,480
GDKD-24	1015G24008220	1,5	1,990
GDKD-30	1015G30008220	1,5	2,340

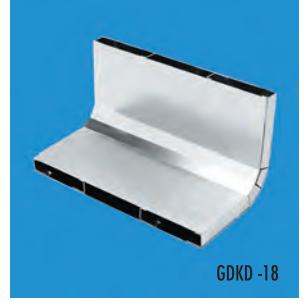

GDKD -18

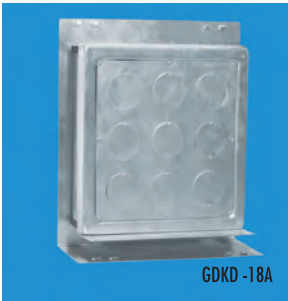

GDKD -18A

90° YUKARI DÖNÜŞ ELEMANI

90° Riser

افعات 90 درجة

Sipariş kodu Order code رمز الطلب	Stok kodu Stock code رمز المخزن	e mm	Ağırlık (Kg/ad.) Weight (Kg/unit) الوزن (كجم/وحدة)
GDKD-18A	1015G18A28220	1,5	4,540
GDKD-24A	1015G24A28220	1,5	4,740

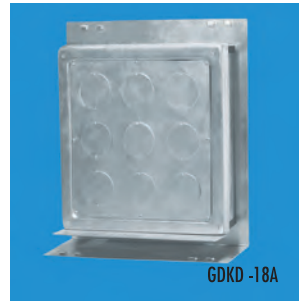

GDKD -18A



YÜKSELTİLMİŞ DÖŞEME ALTI KANAL

In-cavity floor trunking

قناة تمديد أرضية مرتفعة

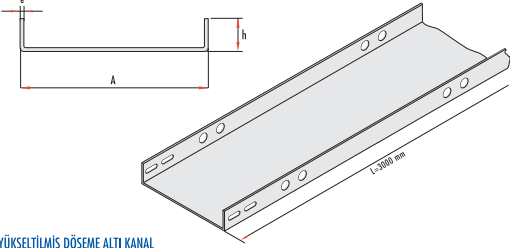

YÜKSELTİLMİŞ DÖŞEME ALTI KANAL
In-cavity floor trunking
قناة تمديد أرضية مرتفعة

YÜKSELTİLMİŞ DÖŞEME ALTI KANAL
In-cavity floor trunking

Sipariş kodu Order code رمز الطلب	Stok kodu Stock code رمز المخزن	A mm	h mm	e mm	Ağırlık (Kg/mt.) Weight (Kg/mt) الوزن (كجم/م)
GYDK-10	1015001018220	100	50	1	1,700
GYDK-20	1015002028220	200	50	1,5	3,750
GYDK-30	1015003028220	300	50	1,5	5,100
GYDK-40	1015004028220	400	50	1,5	6,400
GYDK-50	1015005028220	500	50	1,5	7,700
GYDK-B10	1015081018220	100	60	1	1,800
GYDK-B20	1015082028220	200	60	1,5	4,000
GYDK-B30	1015083028220	300	60	1,5	5,350
GYDK-B40	1015084028220	400	60	1,5	6,650
GYDK-B50	1015085028220	500	60	1,5	8,000

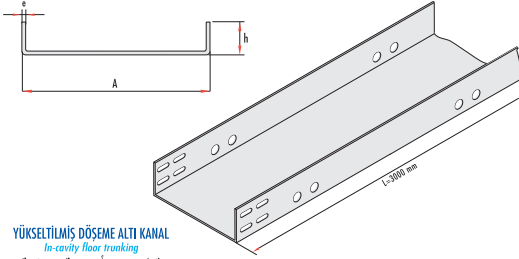

YÜKSELTİLMİŞ DÖŞEME ALTI KANAL
In-cavity floor trunking
قناة تمديد أرضية مرتفعة

YÜKSELTİLMİŞ DÖŞEME ALTI KANAL
In-cavity floor trunking

قناة تمديد أرضية مرتفعة

Sipariş kodu Order code رمز الطلب	Stok kodu Stock code رمز المخزن	A mm	h mm	e mm	Ağırlık (Kg/mt.) Weight (Kg/mt) الوزن (كجم/م)
GYDK-C10	10150C1018220	100	100	1	2,550
GYDK-C20	10150C2028220	200	100	1,5	5,100
GYDK-C30	10150C3028220	300	100	1,5	6,400
GYDK-C40	10150C4028220	400	100	1,5	7,750
GYDK-C50	10150C5028220	500	100	1,5	9,000

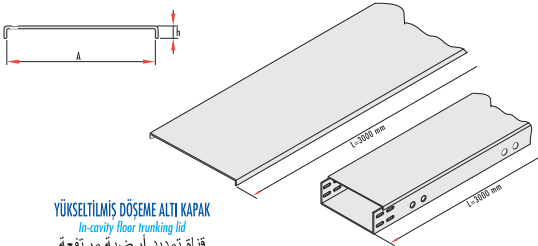

YÜKSELTİLMİŞ DÖŞEME ALTI KAPAK
In-cavity floor trunking lid
قناة تمديد أرضية مرتفعة

YÜKSELTİLMİŞ DÖŞEME ALTI KANAL
In-cavity floor trunking

قناة تمديد أرضية مرتفعة

Sipariş kodu Order code رمز الطلب	Stok kodu Stock code رمز المخزن	A mm	h mm	e mm	Ağırlık (Kg/mt.) Weight (Kg/mt) الوزن (كجم/م)
GYDK-10K	1015C1K18220	100	9	1	1,000
GYDK-20K	1015C2K18220	200	9	1	1,700
GYDK-30K	1015C3K18220	300	9	1	2,650
GYDK-40K	1015C4K28220	400	9	1,5	5,200
GYDK-50K	1015C5K28220	500	9	1,5	6,500

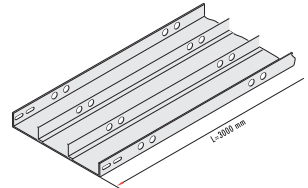
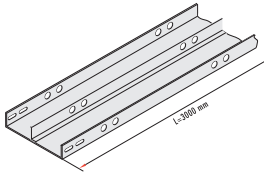

İsteğe bağlı olarak yükseltilmiş döşeme altı kablo kanalları tek ve çift seperatörlü olarak imal edilebilir.
Underfloor cable trays for high floor can be supplied as 2 or 3 compartments in accordance to requirement.

قنوات التمديد الأرضية يمكن تصنيعها بحجرتين أو ثلاثة حسب المتطلبات



ÖZELLİKLER SPECIFICATION لمواصفات

ÖLÇÜLER Dimensions

O/A ÇAPI O/A Diameter	قطر أو/يه	150 mm
İÇ ÇAPI Internal Diameter	قطر الداخلي	120 mm
DERİNLİK Depth	عمق	65 mm

MALZEME Material	المواد	High Impact ABS
---------------------	--------	-----------------

RENK Colour	اللون	RAL/7016
----------------	-------	----------

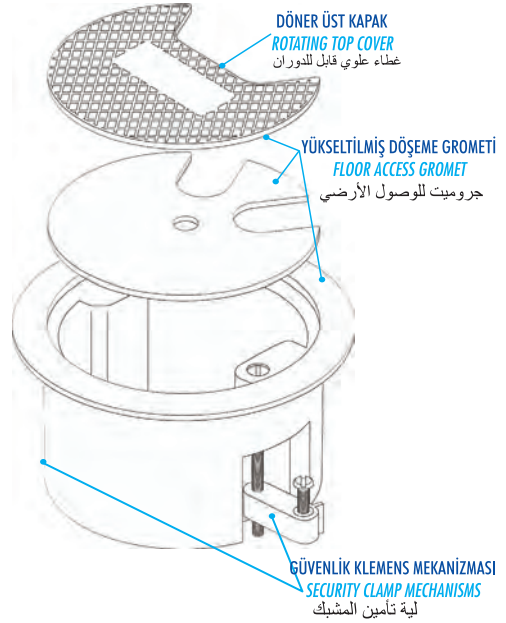
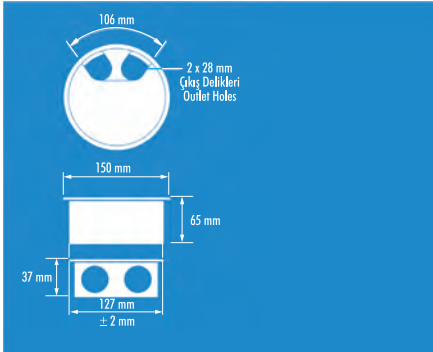

YÜKSELTİLMİŞ DÖŞEME GROMETİ Floor Access Gromet

جروميت للوصول الأرضي

Sipariş kodu Order code	Stok kodu Stock code	Ağırlık (Kg/ad.) Weight (Kg/unit)
رمز الطلب	رمز المخزن	الوزن (كجم/وحدة)
GROM	822400005521050	0.610



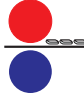

ALÜMİNYUM PARAPET KANALLAR

Aluminium trunkings

تمديدات ألومنيوم



GOR-01

TEK GÖZLÜ ALÜMİNYUM KANAL

Aluminium trunking with single compartment

تمديدات ألومنيوم مع مقصورة واحدة

Sipariş kodu Order code رمز الطلب	Stok kodu Stock code رمز المخزن	Ebat dimension mm	Ağırlık (Kg/mt.) Weight (Kg/mt) (الوزن (كجم/م))
GOR - 01	101700212AL1	60 x 55	0,970



GOR-01



GOR-02

İKİ GÖZLÜ SEPARATÖRLÜ ALÜMİNYUM KANAL

Aluminium trunking with double compartment

تمديدات ألومنيوم مع مقصورة مزدوجة

Sipariş kodu Order code رمز الطلب	Stok kodu Stock code رمز المخزن	Ebat dimension mm	Ağırlık (Kg/mt.) Weight (Kg/mt) (الوزن (كجم/م))
GOR - 02	101700202AL1	120 x 55	1,720



GOR-02



GOR-03

İKİ YÖNLÜ SIRT SIRTA ALÜMİNYUM KANAL

Two faces, back to back aluminium trunking

تمديدات ألومنيوم ، ذات وجهين ، خلفية

Sipariş kodu Order code رمز الطلب	Stok kodu Stock code رمز المخزن	Ebat dimension mm	Ağırlık (Kg/mt.) Weight (Kg/mt) (الوزن (كجم/م))
GOR - 03	101700192AL1	120 x 60	1,670

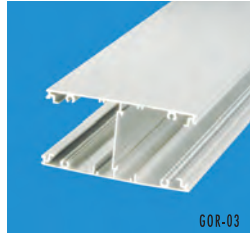

GOR-03



GOR-09

ALÜMİNYUM KANAL KAPAK

Aluminium trunking cover

غطاء تمديدات الألومنيوم

Sipariş kodu Order code رمز الطلب	Stok kodu Stock code رمز المخزن	Ağırlık (Kg/mt.) Weight (Kg/mt) (الوزن (كجم/م))
GOR - 09	101700012AL1	0,250

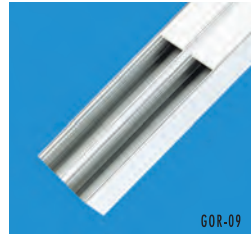

GOR-09

Maksimum 6000 mm'ye kadar belirteceğiniz ölçülerde imalat yapılır.
The aluminium trunking is manufactured up to 6000 mm in accordance to your requirement
يمكن تصنيعها تمديدات ألومنيوم حتى 6 طول عند الطلب



ALÜMİNYUM PARAPET KANALLAR Aluminium trunkings تمديدات ألومنيوم



GOR-07

ALÜMİNYUM DİKEY DÖNÜŞ

Aluminium vertical bend

تمديدات ألومنيوم

Sipariş kodu Order code رمز الطلب	Stok kodu Stock code رمز المخزن	Ebat dimension mm	Ağırlık (Kg/ad.) Weight (Kg/unit) الوزن (كجم/وحدة)
GOR - 07	101700052AL1	60 x 55	0,430



GOR-07



GOR-08

ALÜMİNYUM YATAY DÖNÜŞ

Aluminium horizontal bend

انحناء ألومنيوم أفقي

Sipariş kodu Order code رمز الطلب	Stok kodu Stock code رمز المخزن	Ebat dimension mm	Ağırlık (Kg/ad.) Weight (Kg/unit) الوزن (كجم/وحدة)
GOR - 08	101700042AL1	120 x 55	0,770

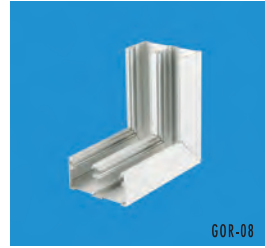

GOR-08



GOR-11

SONLANDIRMA KAPAĞI (POLİKARBONAT)

Polycarbonate end cap

غطاء طرفي بوليكاربونات

Sipariş kodu Order code رمز الطلب	Stok kodu Stock code رمز المخزن	Ebat dimension mm	Ağırlık (Kg/ad.) Weight (Kg/unit) الوزن (كجم/وحدة)
GOR - 11	101700032AL1	60 x 55	0,009



GOR-11



ALÜMİNYUM PARAPET KANALLAR

Aluminium trunkings

تمديدات ألومنيوم



Maksimum 6000 mm'ye kadar belirteceğiniz ölçülerde imalat yapılır.
Malzemenin üzerinde görünen aksesuarlar ürüne dahil değildir.

*The aluminium trunking is manufactured up to 6000 mm in accordance to your requirement.
The illustrated accessories on the product are not supplied with these codes.*

يمكن تصنيعها تمديدات ألومنيوم حتى 6م طول عند الطلب
الاكسسوارات في التمديدات المعروضة أعلاه غير متضمنة في المنتجات



ALÜMİNYUM PARAPET KANALLAR

Aluminium trunkings

تمديدات ألومنيوم



GDKF-401

UPS PRİZ <i>UPS Socket</i> مقبس UPS		
Sipariş kodu <i>Order code</i> رمز الطلب	Stok kodu <i>Stock code</i> رمز المخزن	Ağırlık (Kg/ad.) <i>Weight (Kg/unit)</i> الوزن (كجم/وحدة)
GDKF-401	101504010PLSO	0,036



GDKF-401



GDKF-402

TOPRAKLI PRİZ <i>Socket with earthing</i> مع مقبس التوصيل الأرضي		
Sipariş kodu <i>Order code</i> رمز الطلب	Stok kodu <i>Stock code</i> رمز المخزن	Ağırlık (Kg/ad.) <i>Weight (Kg/unit)</i> الوزن (كجم/وحدة)
GDKF-402	101504020PLSO	0,032



GDKF-402



GDKF-403

ANAHTAR <i>Switch</i> لمفتاح		
Sipariş kodu <i>Order code</i> رمز الطلب	Stok kodu <i>Stock code</i> رمز المخزن	Ağırlık (Kg/ad.) <i>Weight (Kg/unit)</i> الوزن (كجم/وحدة)
GDKF-403	101504030PLSO	0,035



GDKF-403



GDKF-603

DATA PRİZİ <i>Data Socket</i> بيانات المقبس		
Sipariş kodu <i>Order code</i> رمز الطلب	Stok kodu <i>Stock code</i> رمز المخزن	Ağırlık (Kg/ad.) <i>Weight (Kg/unit)</i> الوزن (كجم/وحدة)
GDKF-603	101506030PKLO	0,012



GDKF-603



GDKF-604

TELEFON PRİZİ <i>Telephone Socket</i> مقبس الهاتف		
Sipariş kodu <i>Order code</i> رمز الطلب	Stok kodu <i>Stock code</i> رمز المخزن	Ağırlık (Kg/ad.) <i>Weight (Kg/unit)</i> الوزن (كجم/وحدة)
GDKF-604	101506040BKLO	0,008



GDKF-604



GOR-10

DEMİR MONTAJ PLAKASI <i>Steel mounting plate</i> لوحة تعليق ستيل		
Sipariş kodu <i>Order code</i> رمز الطلب	Stok kodu <i>Stock code</i> رمز المخزن	Ağırlık (Kg/ad.) <i>Weight (Kg/unit)</i> الوزن (كجم/وحدة)
GOR-10	101700022AL1	0,027

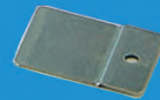

GOR-10

Tüm Alüminyum kanallar 45 mm formatındaki Tel, Data, Şebeke veya UPS tipi tırnaklı prizlere kaide veya çerçeve gerekmeden uyumludur. Eloksal veya RAL serisi boyaya kaplanabilmektedir. Vidalamak gerekmemektedir.

All Aluminium trunkings do fit to tel,data, elc and UPS sockets which are in 45 mm format Coating available for Eloksal or RAL series painting. No screws needed.